

Вход

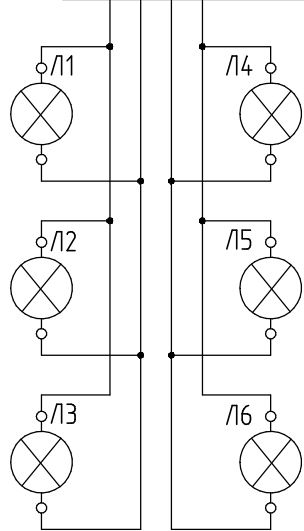

Вход

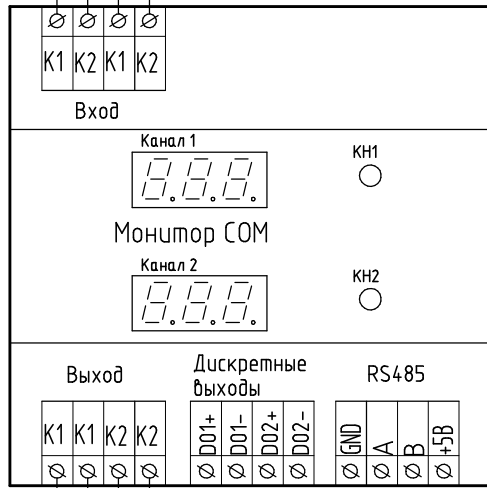
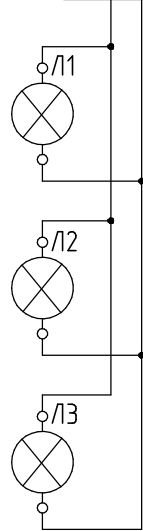
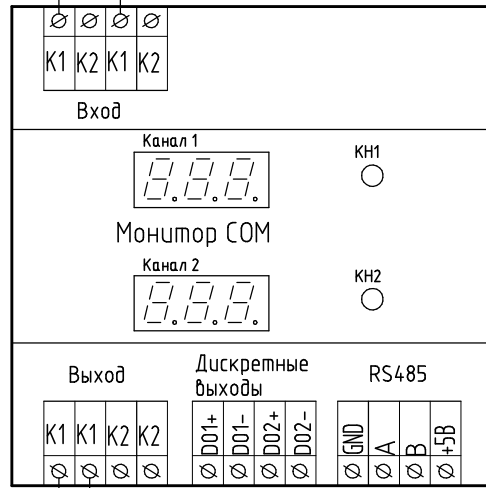
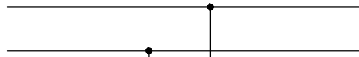

Вход

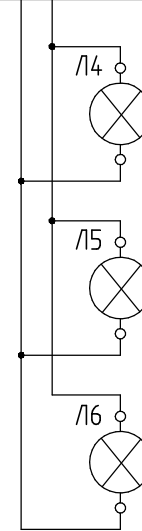
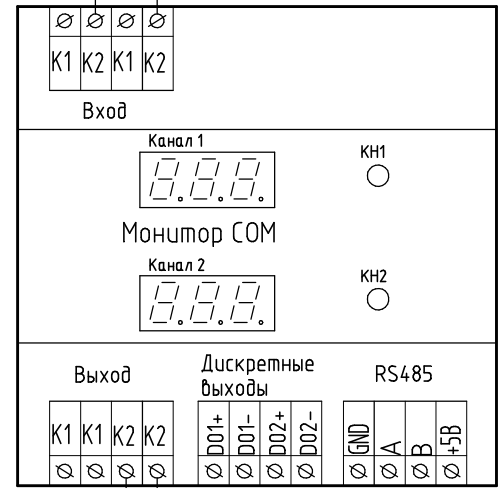

Взам. инв. №

Подп. и дата

Инв. № подл.

Изм.	Колуч.	Лист	№ док.	Подп.	Дата

Лист